

Wireless IR Remote Control Extender Kit with Pairing Function

The Wireless IR Remote Extender is designed to get your remote control's signal where it needs to go. Control your home theater video sources like Blu-Ray, DVD, video players and receivers, and anything else that uses a standard IR remote control through walls and other obstructions by extending the IR signal wirelessly with this kit. With our unique Multizone technology, you have even more control over where you want your IR signals to go and where not to go.

Safety

Please read all instructions carefully before using the device.

- Unpack the equipment carefully and save the original box and packing material for possible future shipment.
- Follow basic safety precautions to reduce the risk of fire, electrical shock and injury.
- Do not dismantle the housing or modify the module in any way. It may result in electrical shock or burn.
- Using equipment or parts not meeting the product's specifications may cause damage, deterioration or malfunction.
- Refer all servicing to qualified service personnel at Digital World NZ LTD.
- To prevent fire or shock hazard, do not expose the unit to rain, moisture or install this product near water.
- Do not use liquid or aerosol cleaners to clean this unit. Always unplug the power to the device before cleaning.
- Unplug the power cord when left unused for a long period of time.
- Please do not burn or mix with general household waste.

Box Contents

- Wireless IR Receiver
- Wireless IR Transmitter
- Dual IR Emitter Cable
- IR Receiver Cable
- (2) 5V 500mA Power Supply
- User Guide

Setup: Step One

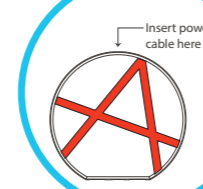

It is easy to mistake the IR cable port on the front for the power port. Please ensure that the power adapter is plugged into the appropriate port at the back.

Setup: Step Two



Place the yellow unit next to your display.

Setup: Step Three

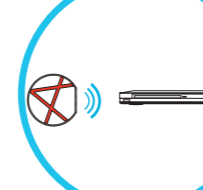

Place the red unit in front of the device that you wish to control. Ensure that the IR emitter has a clear line of sight to the IR "eye" of your device.

Optional IR Cables

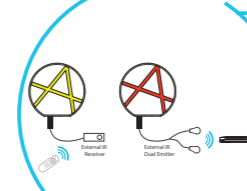

If you want to extend the reach or hide the receiver or emitter, connect the external IR receiver to the yellow unit, connect the external IR dual emitter to the red unit. The external IR receiver will add another receiver you can point your remote at. The external IR dual emitter can attach to the IR "eye" of the device you wish to control.

Multizone



Wireless Receivers will only communicate with the Wireless Transmitter that are set to the same channel. The Wireless supports up to ten unique channels of communication. Setting the frequency to "0" will allow communication to previous models of the Wireless IR Extender. After changing the frequency, please reset the device.

Setup One

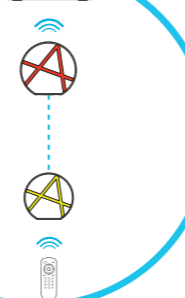

Setup Three

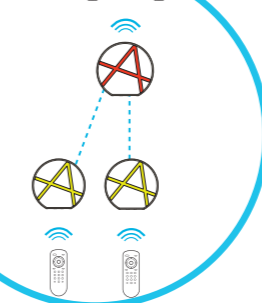

Setup Two



Setup Four

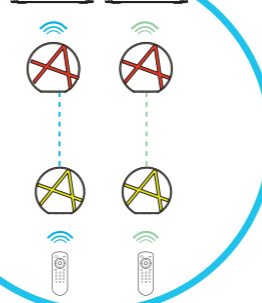

More receivers and emitters can be added as you need them.

Port Diagram

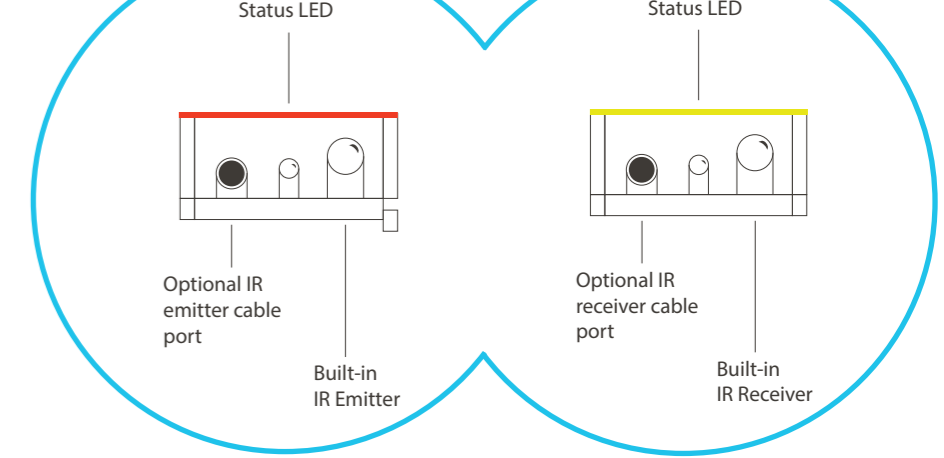

SPECIFICATIONS

- IR:
1. Compatible with all Universal full band carrier frequency infrared Remote
 2. Better IR receive sensitivity (distance), over 7 meters
- RF:
1. Long range transmission over 100-300 meter (open space)
 2. 915.1MHz RF technology to ignore current 433MHz RF-interference
 3. FSK modulation:
Better signal sensitivity than ASK modulation
Better Anti RF-interference than ASK modulation
Better noise suppression
 4. Digital encrypted function ensures safety and reliability

